

Terminal Strip Option

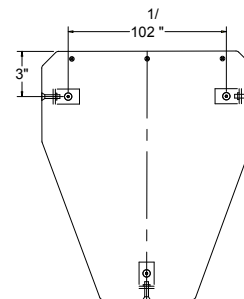
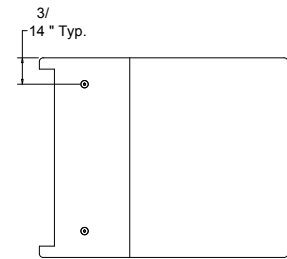
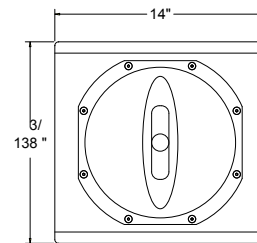
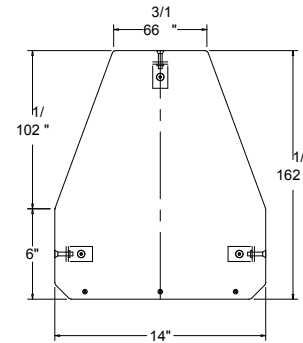
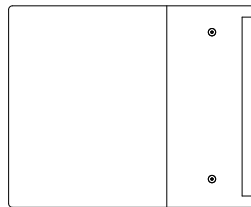
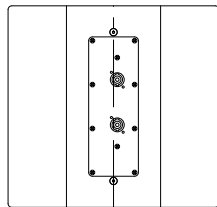
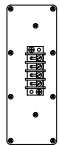

Notes:
Attachment point locations are approximate. Design attachment plates with slotted holes for

DRAWING APPLIES TO
STX2M84, STX2M94

REV	DESCRIPTION	DATE	BY

UNLESS OTHERWISE SPECIFIED	INTL.	DATE
DIMENSIONS ARE IN INCHES	DRAWN	C.R.
TOLERANCES ARE	CHEK	T04
DECIMALS	DESIGN	
XXX .01	ENG	
XXX.005	APPROV	
	APPROV	
	REF DWG	

RENKUS-HEINZ, inc.
TITLE: **Speaker Assembly**
STX2M

THE MATERIAL CONTAINED HEREIN IS PROPRIETARY TO RENKUS-HEINZ AND SHALL NOT BE REPRODUCED, DISCLOSED, OR USED FOR ANY OTHER PURPOSE WITHOUT THE WRITTEN APPROVAL OF RENKUS-HEINZ.

NEXT ASSY:	USED ON:	DO NOT SCALE DRAWING
APPLICATION		

SIZE	CODE IDENT	DWG NO.	REV
C			A

SCALE: 1 = 1 WEIGHT SHEET 1 OF 1